

EA

**Neurochirurgie, Laminektomie
Neurosurgery, Laminectomy
Neurochirurgie, Laminectomie
Neurocirugía, Laminectomía
Neurochirurgia, Laminectomia**

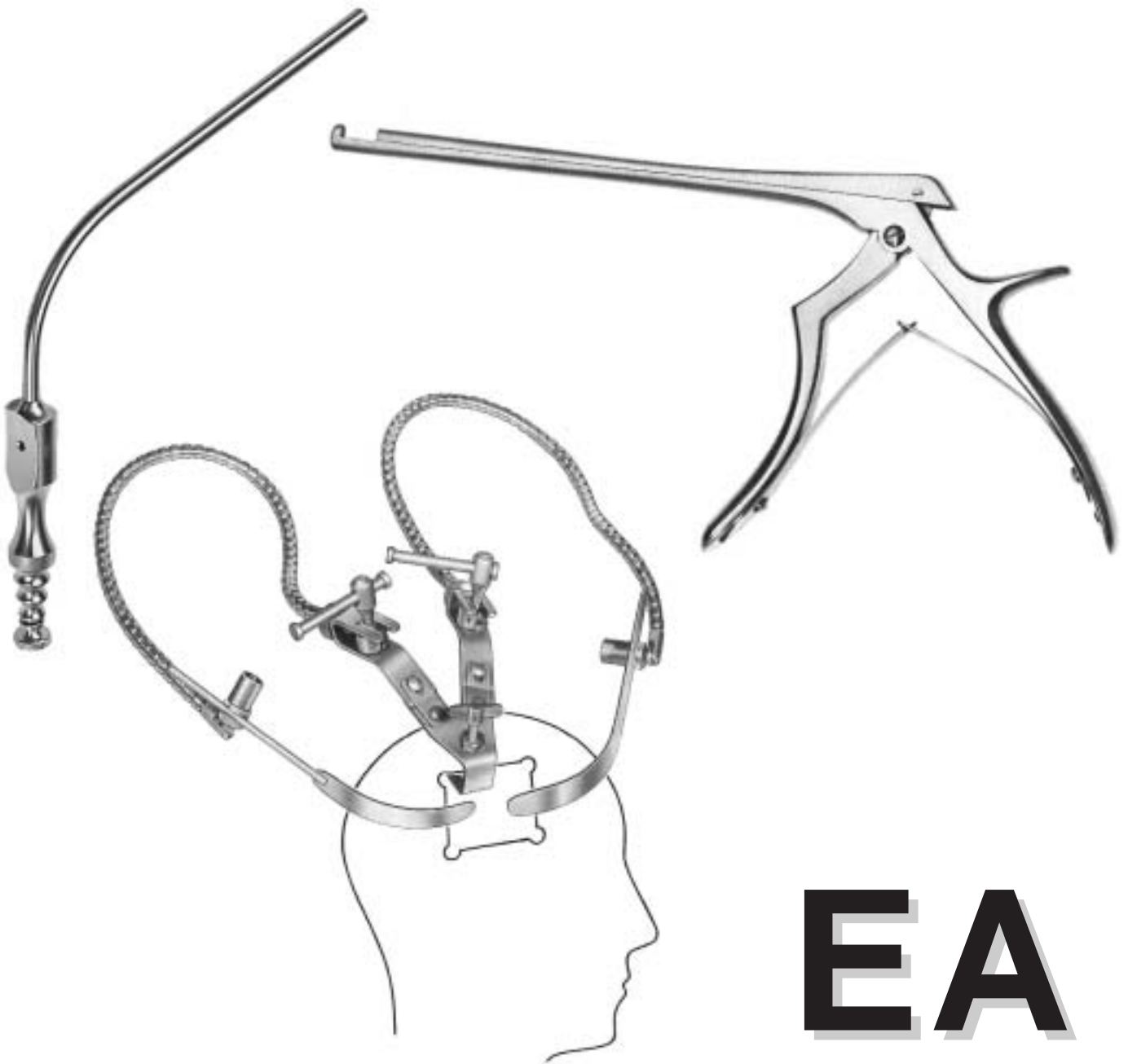

EA

EA

Hirnaht
Brain Suture
Suture cérébrale
Sutura cerebral
Sutura cerebrale



cm McKenzie
15 EA-101-15
19 EA-101-19

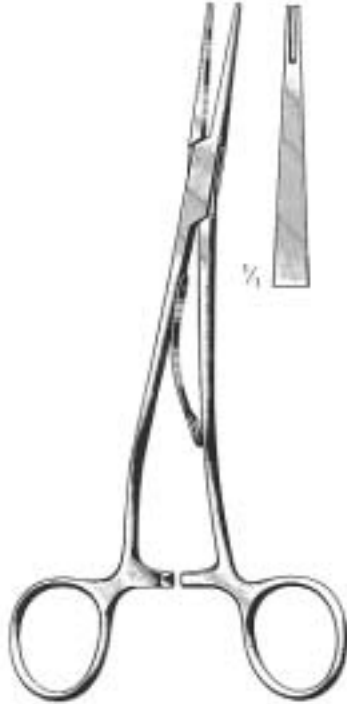

cm McKenzie
15 EA-103-15
19 EA-103-19



cm SMITHWICK
23 EA-105-23
26 EA-105-26

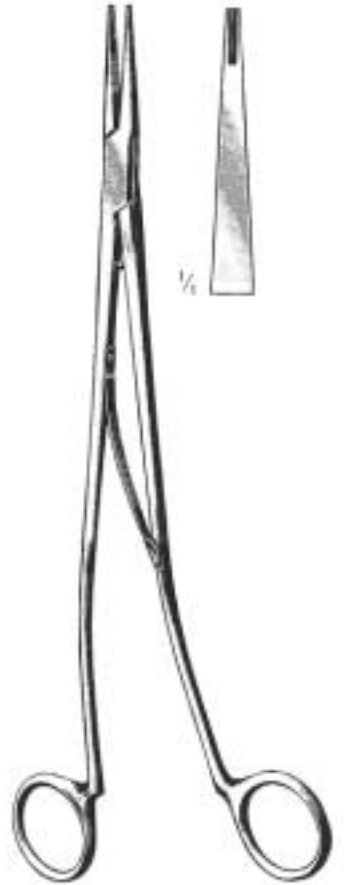

cm SWEET
23 EA-107-23
26 EA-107-26



OLIVECRONA-TOENNIS
EA-109-14



EA-201-00

EA-200-00
148x40x6 mm



CRUTCHFIELD
EA-205-01



CRUTCHFIELD
EA-205-02



EA-206-35
3,5 mm ø



EA-206-50
5 mm ø

Kopfhautklammer, -anlegezange
Scalp Hemostasis Clip, Applying Forceps
Pince hémostatique pour le cuir chevelu, pince à poser
Pinza hermostática para cuero cabelludo, pinza para poner
Pinza emostatica per il cuoio capelluto, pinza per applicare e togliere



RANEY
EA-207-00



RANEY
EA-208-00



DANDY
EA-501-20
20 cm



DANDY
EA-502-20
20 cm



DANDY
EA-503-20
20 cm



CUSHING
EA-506-28
28 cm

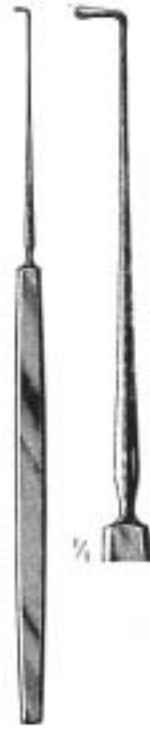

CUSHING
EA-508-28
28 cm



GRAHAM
EA-601-16
16,5 cm



SACHS
EA-604-18
18,5 cm



ADSON
EA-608-20
20 cm



ADSON
EA-609-20
20 cm

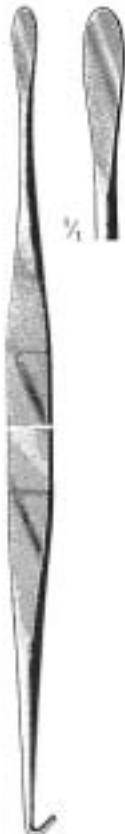

SMITHWICK
EA-700-29
29 cm



EA-800-19



EA-801-19



EA-803-19



LOVE
EA-800-19 - EA-803-19



De MARTEL
EA-900-33
33 cm

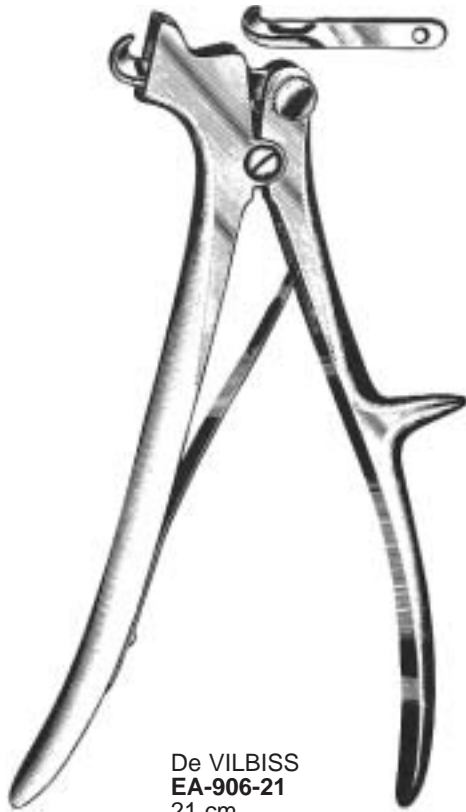

De VILBISS
EA-906-21
21 cm



cm	OLIVECRONA
30	EA-902-30
40	EA-902-40
50	EA-902-50
60	EA-902-60
70	EA-902-70



GIGLI
EA-904-00
1 Paar
1 pair
1 paire
1 par
1 paio

Dura-Dissektoren • Dura Dissectors • Dissecteurs à duremère
Descoladores para la duramadre • Scollatori per la duramadre



TOENNIS
EA-411-25
25 cm



SACHS
EA-413-21



SACHS
EA-415-21



MILLIGAN
EA-417-21



EA-419-22



DAVIS
EA-511-24

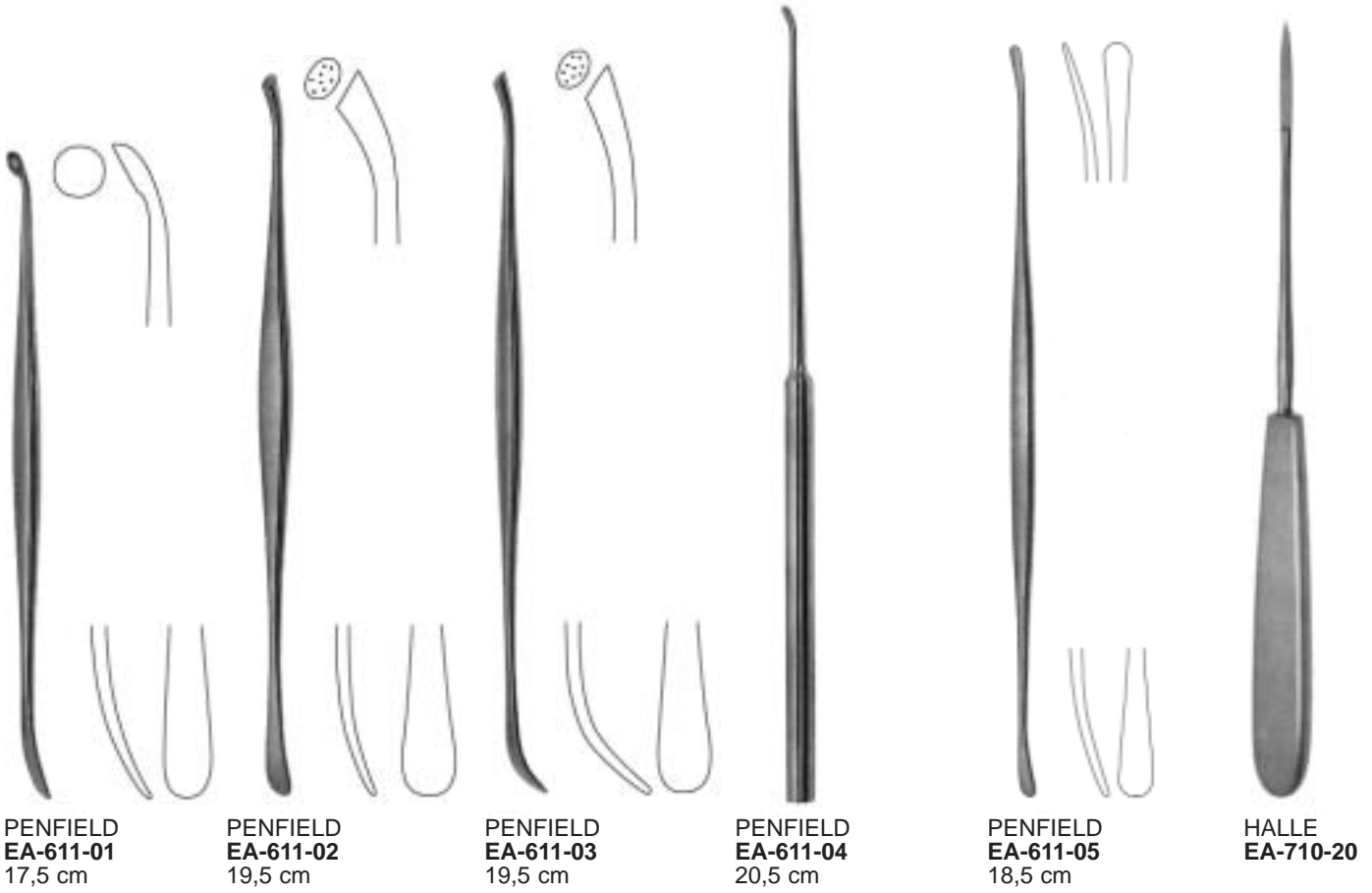

Hypophysenpinzetten • Hypophyseal Forceps • Pincas á hypophyse • Pinzas para hipófisis • Pinze per ipofisi

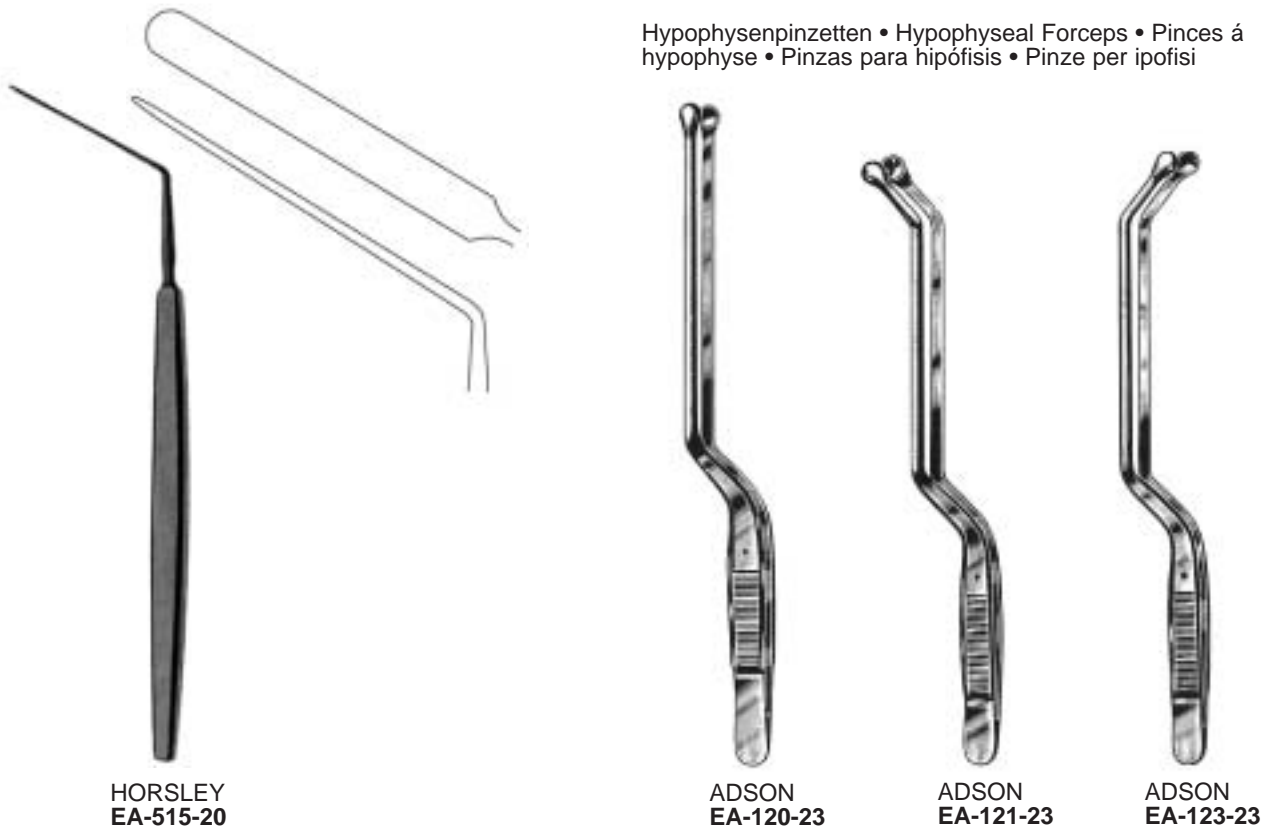

Hirnspatel, Saugrohre
Brain Spatulas, Aspiration Tubes
Spatules cérébr., tubes d'aspir.
Espátulas cerebr., tubos de aspir.
Spatole cerebr., tubi per aspiraz.

EA

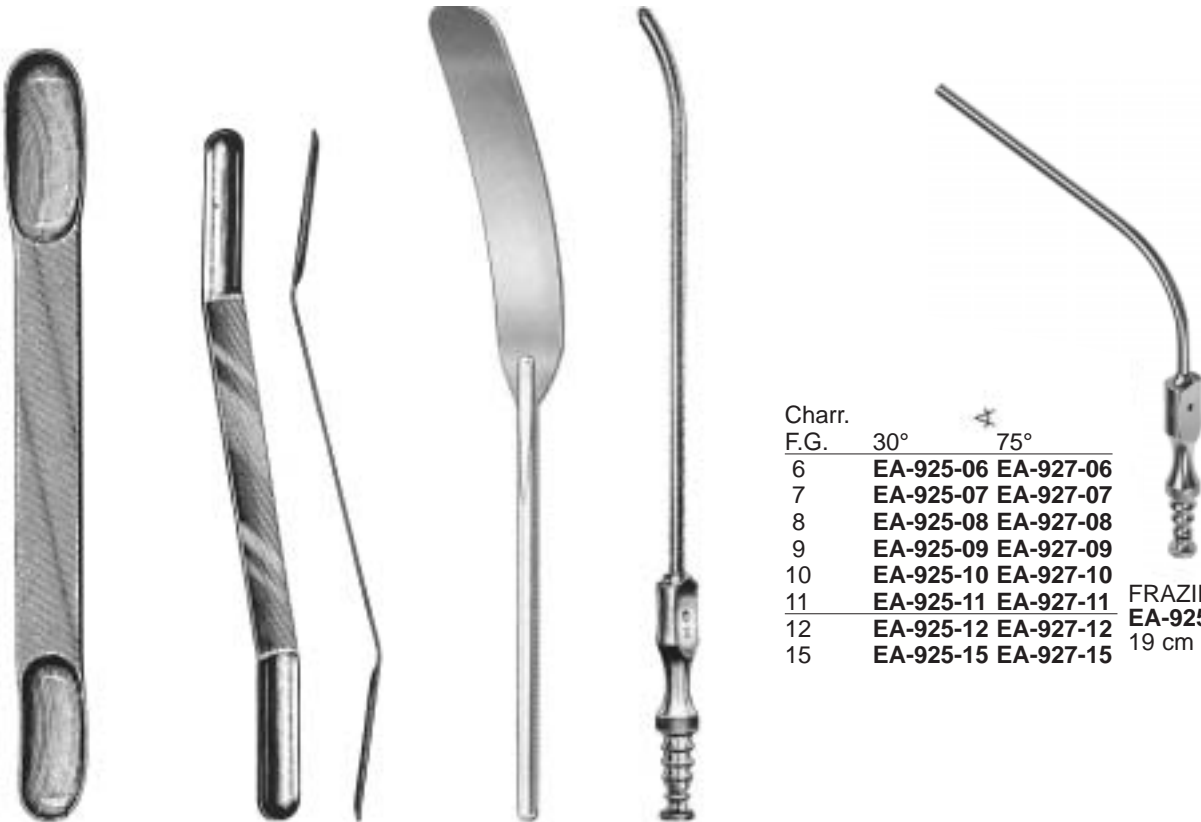

Charr.	F.G.	
	30°	75°
6	EA-925-06	EA-927-06
7	EA-925-07	EA-927-07
8	EA-925-08	EA-927-08
9	EA-925-09	EA-927-09
10	EA-925-10	EA-927-10
11	EA-925-11	EA-927-11
12	EA-925-12	EA-927-12
15	EA-925-15	EA-927-15

FRAZIER
EA-925-06 - EA-927-12
19 cm

mm	CUSHING	mm	OLIVECRONA	mm	HEIFETZ	ADSON
7/9	EA-520-07	7/9	EA-523-07	8	EA-620-08	EA-920-21
11/13	EA-520-11	11/13	EA-523-11	11	EA-620-11	21cm/4 mm
15/18	EA-520-15	15/18	EA-523-15	14	EA-620-14	
18/22	EA-520-18	18/22	EA-523-18	17	EA-620-17	
	180 mm		180 mm			

Wirbelkörperspreizer • Lamina Spreaders •
Ecarteurs pour corps vertébraux •
Speradores para cuerpos vertebrales •
Divaricatori per corpi vertebrali



FRAZIER
EA-928-12
12 cm/3 mm



CLOWARD
EA-041-16



INGE
EA-045-17 - EA-045-27

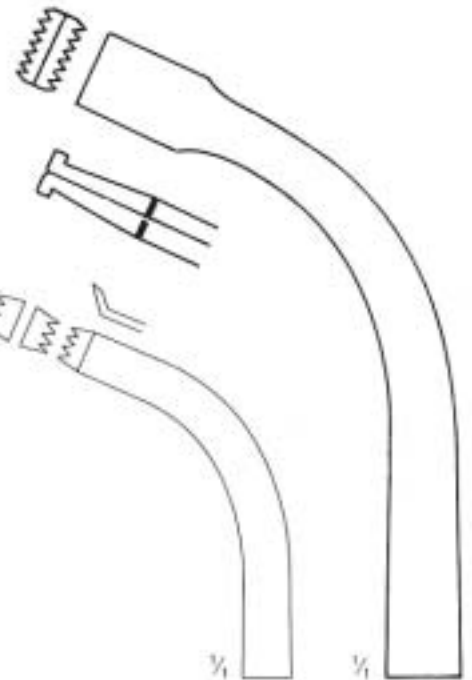

EA-045-17
17 cm

EA-045-27
27 cm

EA

Laminektomie
Laminectomy
Laminectomie
Laminectomía
Laminectomia

Laminektomie-Zangen
Laminectomy Rongeurs
Pinces emporte-pièce à laminectomie
Pinzas cortantes para laminectomia
Pinze taglianti per laminectomia



CUSHING
2 mm



2x10 mm	L
EA-240-01	12,5 cm
EA-242-01	18,0 cm



2x10 mm/45°	L
EA-240-01	12,5 cm
EA-242-01	18,0 cm

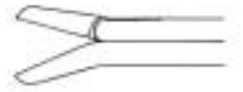

2x10 mm/45°	L
EA-240-03	12,5 cm
EA-242-03	18,0 cm

LOVE-GUENWALD
3 mm



3x10 mm	L
EA-340-01	12,5 cm
EA-342-01	18,0 cm



3x10 mm/45°	L
EA-340-01	12,5 cm
EA-342-01	18,0 cm



3x10 mm/45°	L
EA-340-03	12,5 cm
EA-342-03	18,0 cm

SPURLING
4 mm



4x10 mm	L
EA-440-01	12,5 cm
EA-442-01	18,0 cm



4x10 mm/45°	L
EA-440-01	12,5 cm
EA-442-01	18,0 cm

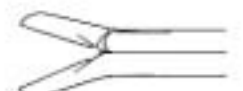

4x10 mm/45°	L
EA-440-03	12,5 cm
EA-442-03	18,0 cm

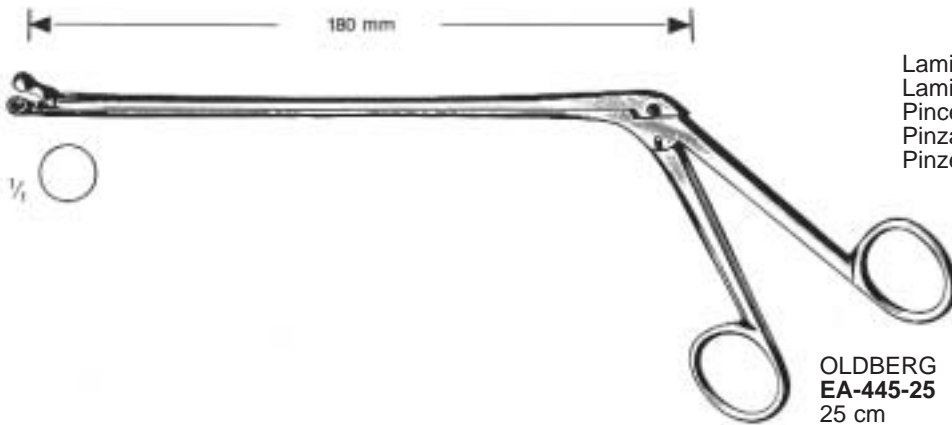

Laminektomie-Zangen
Laminectomy Rongeurs
Pinces emporte-pièce á laminectomie
Pinzas cortantes para laminectomia
Pinze taglianti per laminectomia

OLDBERG
EA-445-25
25 cm

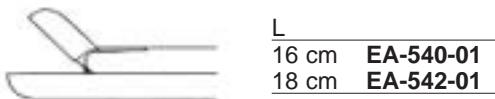

L
16 cm EA-540-01
18 cm EA-542-01

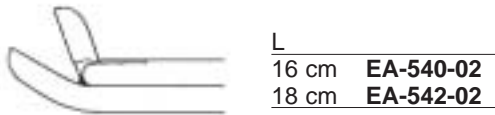

L
16 cm EA-540-02
18 cm EA-542-02

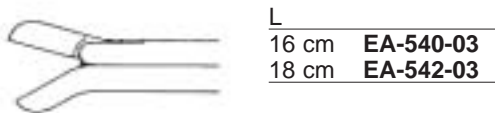

L
16 cm EA-540-03
18 cm EA-542-03



FERRIS-SMITH
EA-540-01 - EA-542-03
3 x 10 mm

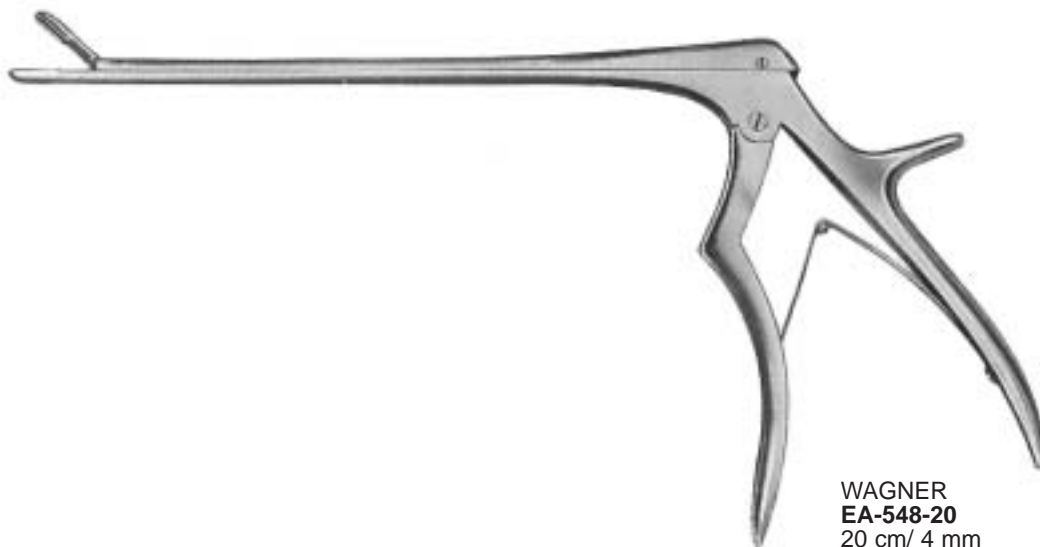

WAGNER
EA-548-20
20 cm/ 4 mm

Bandscheiben-Stanzen
Intervertebral Disc, Rongeurs
Pincas emporte-pièce pour lames intervertébrales
Pinzas sacabocado para discos intervertebrales
Pinze taglienti per dischi intervertebrali

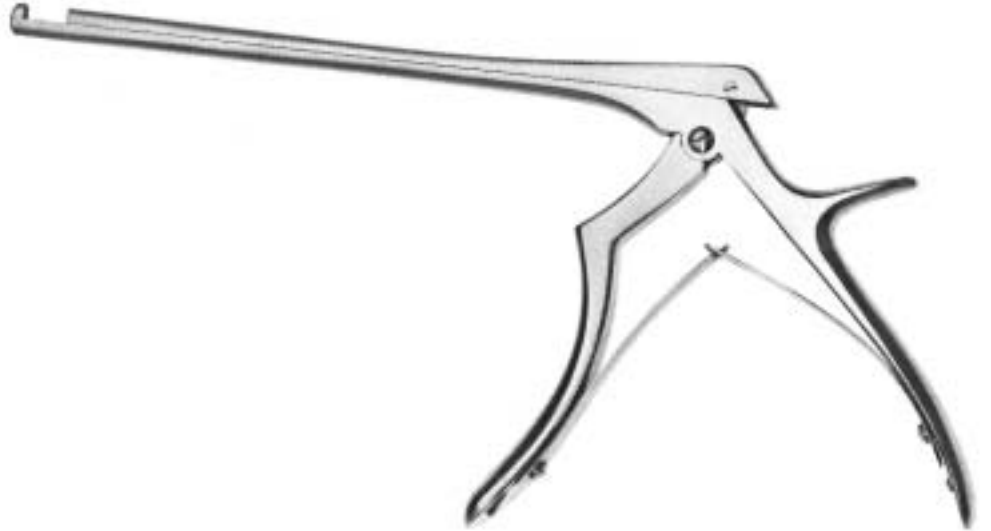

FERRIS-SMITH-Kerrison
EA-150-01 -EA-152-05
18 cm

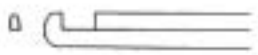

EA-150-01
1 mm

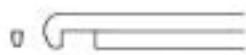

EA-151-01
1 mm



EA-150-02
2 mm

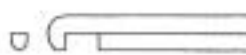

EA-151-02
2 mm

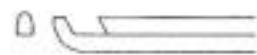

EA-152-02
2 mm

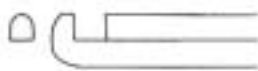

EA-150-03
3 mm

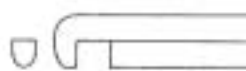

EA-151-03
3 mm



EA-152-03
3 mm

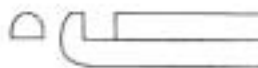

EA-150-04
4 mm

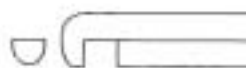

EA-151-04
4 mm

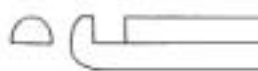

EA-150-05
5 mm



EA-151-05
5 mm



EA-152-05
5 mm

Bandscheiben-Stanzen
Intervertebral Disc, Rongeurs
Pinces emporte-pièce pour lames intervertébrales
Pinzas sacabocado para discos intervertebrales
Pinze taglianti per dischi intervertebrali

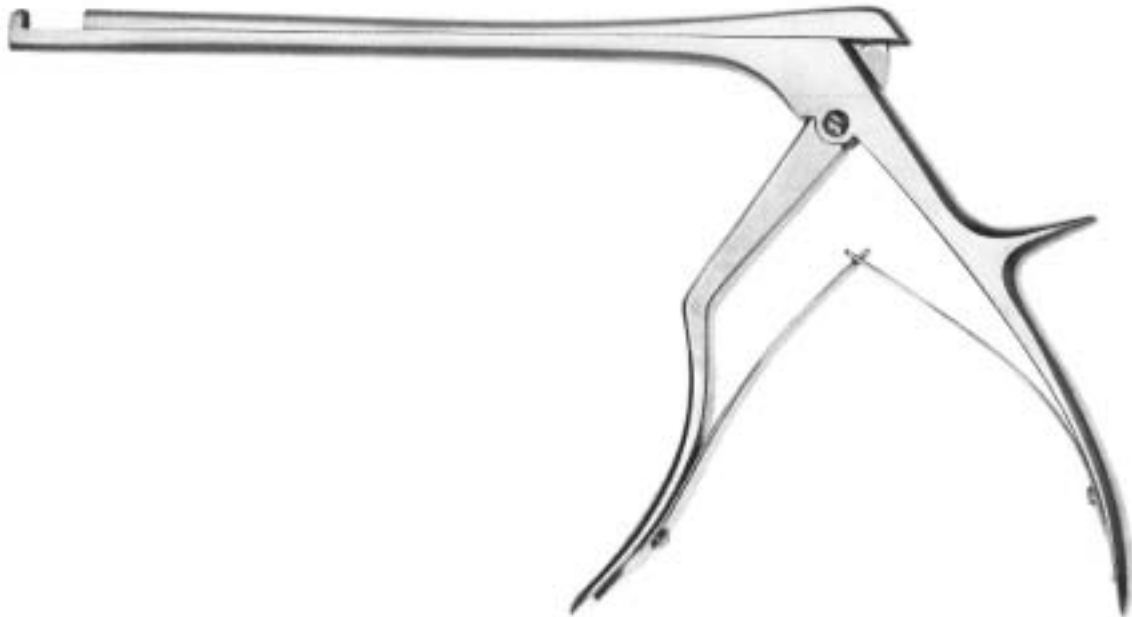

COLCLOUGH
EA-250-03 - EA-255-05

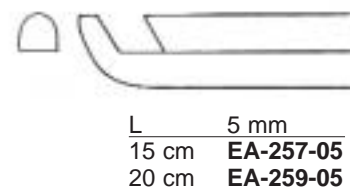
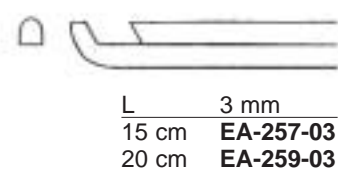
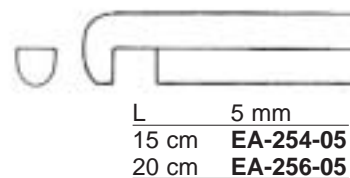
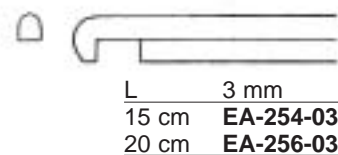
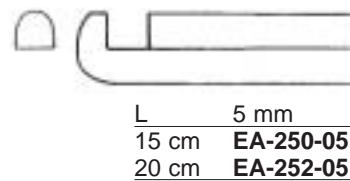
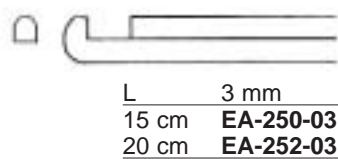

Verlangen Sie unseren Spezialkatalog für
Please ask for our special catalogue for
Demandez notre catalogue spécial pour
Pidan nuestro catálogo especial para
Chiedete il nostro catalogo speciale per

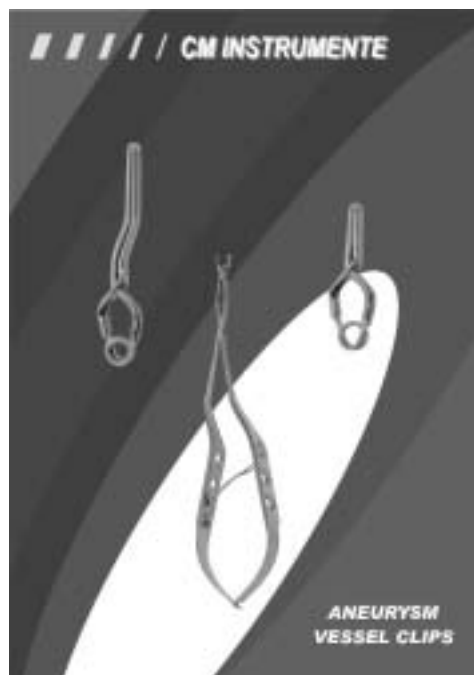

**Verlangen Sie unseren Spezialkatalog für
Please ask for our special catalogue for
Demandez notre catalogue spécial pour
Pidan nuestro catálogo especial para
Chiedete il nostro catalogo speciale per**

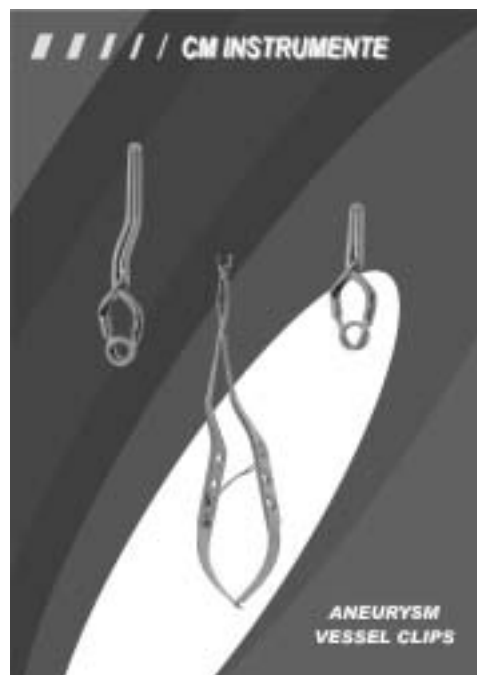

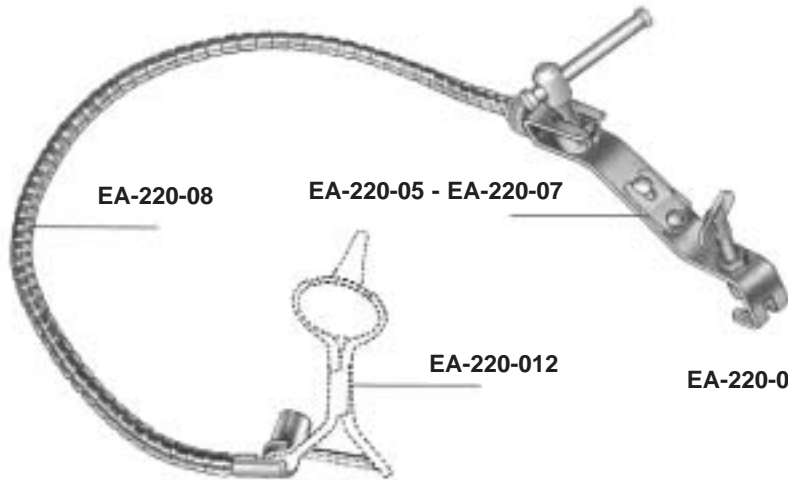

EA-220-08 Spannarm allein
 Flexible arm only
 Bras flexible seul
 Brazo flexible suelto
 Braccio flessibile solo

EA-220-12 Ohrtrichterhalter allein
 Ear specula holder only
 Support pour spéculum auriculaire
 Soporte para espéculo de oídos
 Sostegno per specolo auricolare

EA-220-05 Fixiervorrichtungen für Schädel oder Starrarm
EA-220-06 Fixation bases for skull or rigid holding arm
EA-220-07 Bases pour fixation au crâne ou au bras rigide
 Fijadores para fijación al craneo o al brazo rígido
 Fissatori per fissaggio al cranio o al braccio rigido



EA-220-05

EA-220-05 Fixiervorrichtung am Schädel für 1 Arm
 Fixation base for 1 arm at skull
 Base de fixation pour 1 bras au crâne
 Fijador para 1 brazo al craneo
 Fissatore per 1 braccio al cranio



EA-220-06

EA-220-06 Fixiervorrichtung am Schädel für 2 Arme
 Fixation base for 2 arms at skull
 Base de fixation pour 2 bras au crâne
 Fijador para 2 brazo al craneo
 Fissatore per 2 bracci al cranio



EA-220-07

EA-220-07 Fixiervorrichtung am Starrarm für 1 Arm
 Fixation base for 1 arm at rigid arm
 Base de fixation pour 1 bras au bras rigide
 Fijador para 1 brazo al brazo rígido
 Fissatore per 1 braccio al braccio rigido

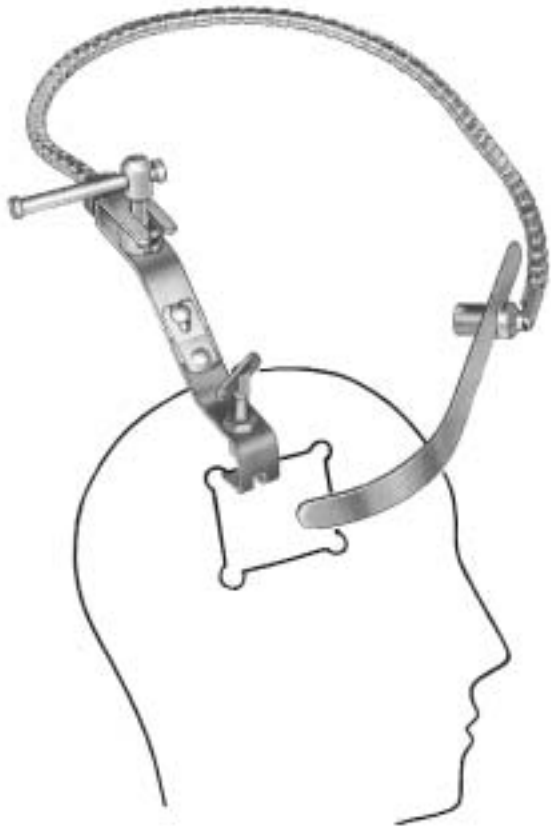

EA-221-00

Hirnspatelhalter, selbsthaltend, flexibel,
für flache Spatel,
mit 1 Spannarm, komplett, bestehend aus:
EA-220-05, EA-220-08, EA-220-09

Brain retractor, self retaining, flexible,
for flat spatula
with 1 flexible arm, complete, consisting of:
EA-220-05, EA-220-08, EA-220-09

Ecarteur autostatique, flexible,
pour des spatules plates,
avec un bras flexible, complet, composé de:
EA-220-05, EA-220-08, EA-220-09

Separador autorretentivo, flexible
para espátulas llanas,
con 1 brazo flexible, completo, compuesto de:
EA-220-05, EA-220-08, EA-220-09

Divaricatore autostatico, flessibile,
per spatole piatte,
con 1 braccio flessibile, completo, composto da:
EA-220-05, EA-220-08, EA-220-09

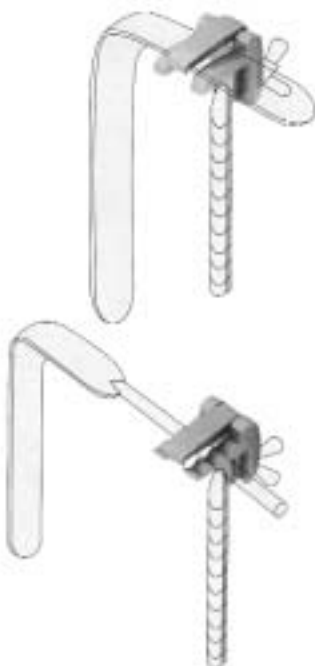

EA-220-09 Halter für flache Hirnspatel
Holder for flat brain spatula
Support pour des spatules plates
Soporte para espátulas llanas
Sostegno per spatole piatte

EA-220-10 Halter für Hirnspatel mit rundem Schaft
Holder for brain spatula with round stem
Support pour des spatules a tige ronde
Soporte para espátulas con vástago redondo
Sostegno per spatole con asta rotonda

EA

LEYLA Fixations-System
LEYLA Fixation System
LEYLA système de fixation
LEYLA sistema de fijación
LEYLA sistema da fissaggio

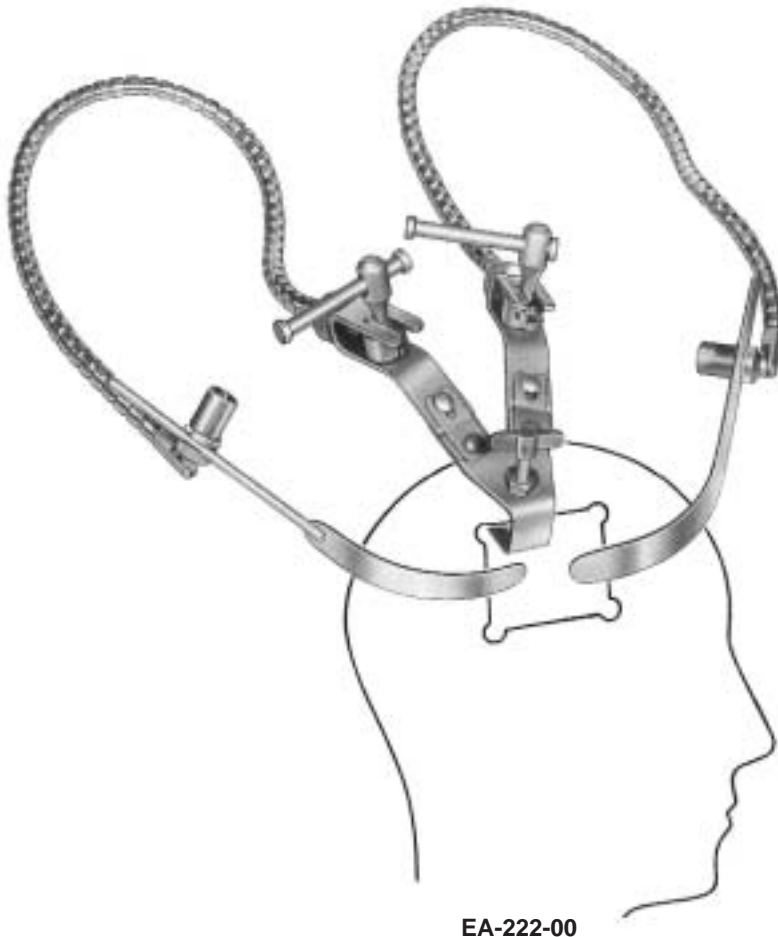

EA-222-00

Hirnspatelhalter, selbsthaltend, flexibel,
für flache Spatel,
mit 2 Spannarmen, komplett, bestehend aus:
2 x EA-220-08, EA-220-06, 2 x EA-220-09

Brain retractor, self retaining, flexible,
for flat spatula,
with 2 flexible arms, complete, consisting of:
2 x EA-220.08, EA-220-06, 2 x EA-220-09

Ecarteur autostatique, flexible,
pour des spatules plates,
avec 2 bras flexibles, complet, composé de:
2 x EA-220-08, EA-220-06, 2 x EA-220-09

Separador autorretentivo, flexible,
para espátulas llanas,
con 2 brazos flexibles, completo, compuesto de
2 x EA-220-08, EA-220-06, 2 x EA-220-09

Divaricatore autostatico, flessibile,
per spatole piatte
con 2 bracci flessibili, completo, composto da:
2 x EA-220-08, EA-220-06, 2 x EA-220-09

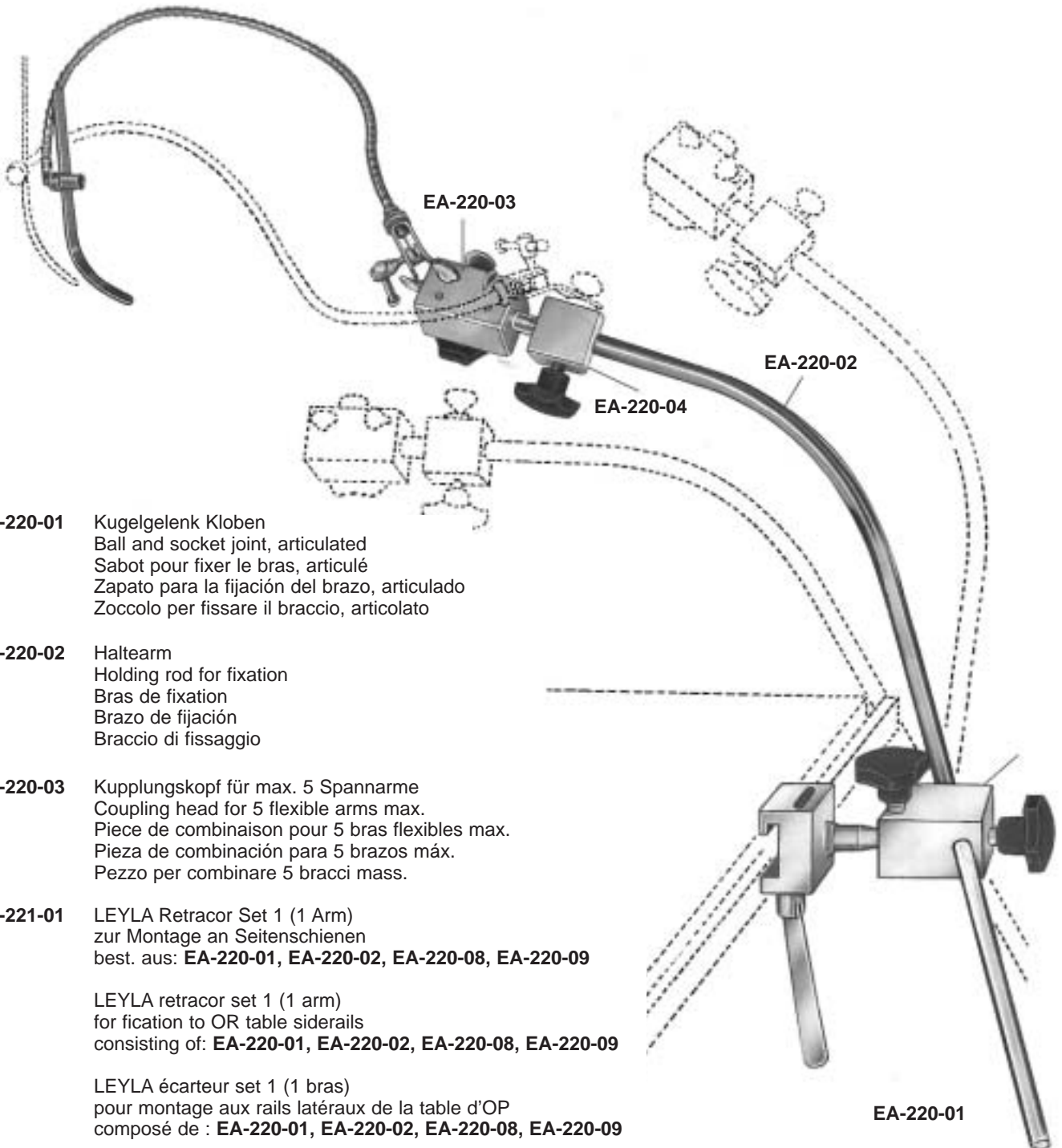

EA-220-01 Kugelgelenk Kloben
 Ball and socket joint, articulated
 Sabot pour fixer le bras, articulé
 Zapato para la fijación del brazo, articulado
 Zoccolo per fissare il braccio, articolato

EA-220-02 Haltearm
 Holding rod for fixation
 Bras de fixation
 Brazo de fijación
 Braccio di fissaggio

EA-220-03 Kupplungskopf für max. 5 Spannarme
 Coupling head for 5 flexible arms max.
 Piece de combinaison pour 5 bras flexibles max.
 Pieza de combinación para 5 brazos máx.
 Pezzo per combinare 5 bracci mass.

EA-221-01 LEYLA Retractor Set 1 (1 Arm)
 zur Montage an Seitenschienen
 best. aus: **EA-220-01, EA-220-02, EA-220-08, EA-220-09**

LEYLA retracor set 1 (1 arm)
 for fixation to OR table siderails
 consisting of: **EA-220-01, EA-220-02, EA-220-08, EA-220-09**

LEYLA écarteur set 1 (1 bras)
 pour montage aux rails latéraux de la table d'OP
 composé de : **EA-220-01, EA-220-02, EA-220-08, EA-220-09**

LEYLA separador set 1 (1 brazo)
 para montar al carril lateral de la mesa operatoria
 compuesto de: **EA- 220-01, EA-200-02, EA-220-08, EA-220-09**

LEYLA divaricatore set 1 (1 braccio)
 per montaggio al tavolo di operazione
 composto da: **EA-220-01, EA-220-02, EA-220-08, EA-220-09**

EA-220-01 Kugelgelenk Kloben
 Ball and socket joint, articulated
 Sabor pour fixer le bras, articulé
 Zapato para la fijación del brazo, articulado
 Zoccolo per fissare il braccio, articolato

EA-220-02 Haltearm
 Holding rod for fixation
 Bras de fixation
 Brazo de fijación
 Braccio di fissaggio

EA-220-03 Kupplungskopf für max. 5 Spannarme
 Coupling head for 5 flexible arms max.
 Pièce de combinaison pour 5 bras flexibles max.
 Pieza de combinación para 5 brazos máx.
 Pezzo per combinare 5 bracci mass.

EA-220-03 Kupplungskopf drehbar
 Coupling head rotatable
 Pièce de combinaison rotative
 Pieza de combinación giratoria
 Pezzo per combinare girevole

EA-222-02 LEYLA Retractor Set 2 (2 Arme) zur Montage an Seitenschiene
 best. aus: **EA-220-01, EA-220-02, EA-220-03, EA-220-04**
 2 x **EA-220-07, 2 x EA-220-08, 2 x EA-220-09**

LEYLA retractor set 2 (2 arms for fixation to OR table siderails
 consisting of: **EA-220-01, EA-220-02, EA-220-03, EA-220-04**
 2 x **EA-220-07, 2 x EA-220-08, 2 x EA-220-09**

LEYLA écarteur set 2 (2 bras) pour montage aux rails latéraux
 de la table d'OP
 composé de : **EA- 220-01, EA-220-02, EA-220-03, EA-220-04**
 2 x **EA-220-07, 2 x EA-220-08, 2 x EA-220-09**

LEYLA separado set 2 (2 brazos) para montar al carril lateral de la
 mesa operatoria
 compuesto de: **EA-220-01, EA-220-02, EA-220-03, EA-220-04**
 2 x **EA-220-07, 2 x EA-220-08, 2 x EA-220-09**

LEYLA divaricatore set 2 (2 bracci) per montaggio
 al tavolo di operazione
 composto da: **EA-220-01, EA-220-02, EA-220-03, EA-220-04**
 2 x **EA-220-07, 2 x EA-220-08, 2 x EA-220-09**

